

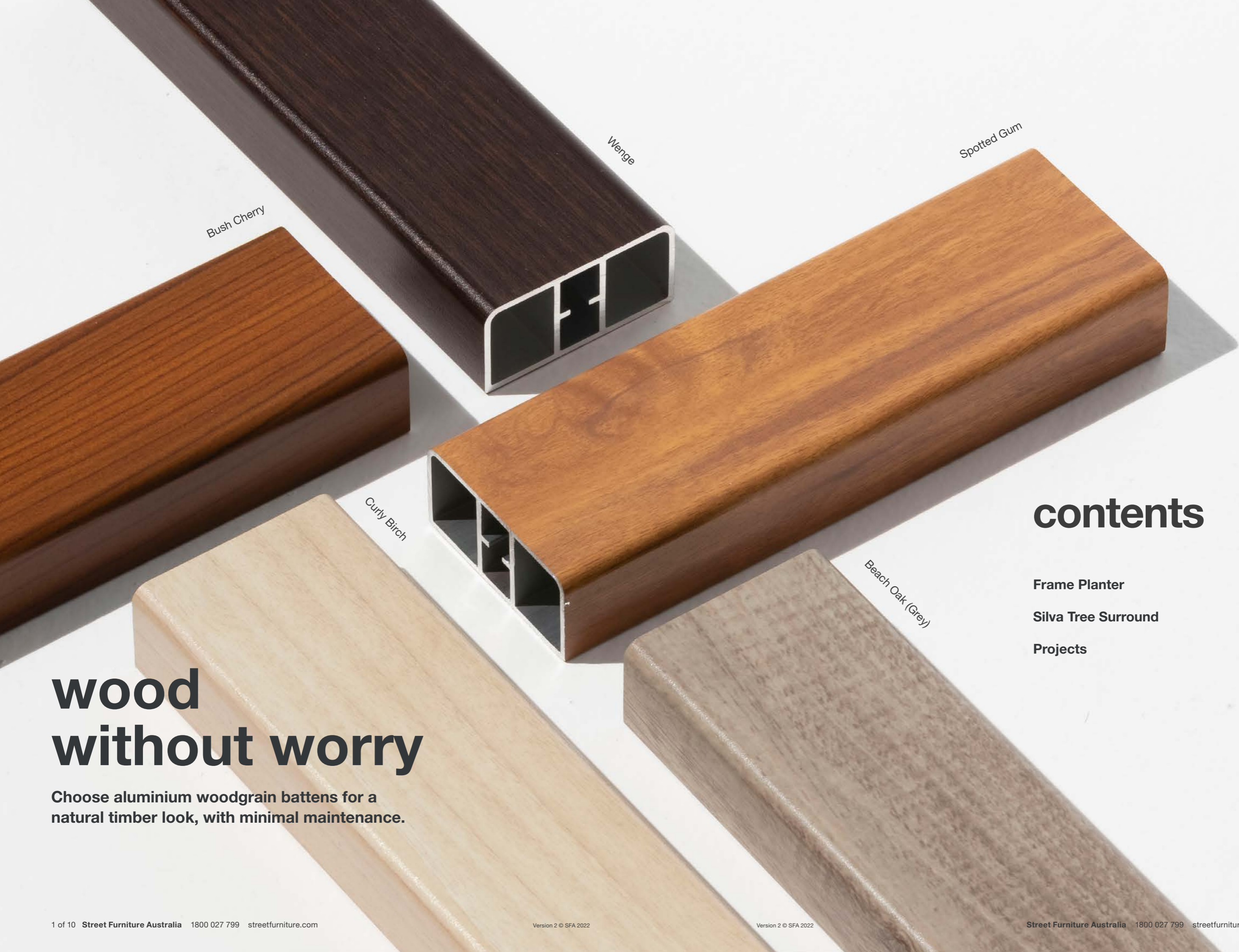

planters and tree surrounds



bringing lasting enjoyment
to public places



Bush Cherry

Wenge

Spotted Gum

Curly Birch

Beach Oak (Grey)

wood without worry

Choose aluminium woodgrain battens for a natural timber look, with minimal maintenance.

contents

Frame Planter	03
Silva Tree Surround	07
Projects	09

frame planter

Round, square and rectangular planters add colour and greenery to soften urban settings. Fabricated to order, includes liner with optional drip tray.

The Rocks, Sydney, NSW.
Frame Planter (PT3) rectangular with perforated body in Textura Monument.



Junction Court, Nowra, NSW by Place Score. Frame Round Planter (PT2), left to right: Round with tailored Starburst perforation, Round Tall in Tailored Nowra Teal with Slots perforation.



01
Frame Planter PT3-BAT Rectangular, Batted Aluminium Spotted Gum battens with Dark Bronze frame.
1000L x 500W x 560H | 19 3/4" W x 39 3/8" L x 22" H



02
Frame Planter PT3 Rectangular Perforated body and frame in Sable Core Ten.
1000L x 500W x 560H | 19 3/4" W x 39 3/8" L x 22" H



05
Frame Round Planter PT2 Round Solid body and frame in Sensation Orange.
500Ø x 500H | Ø19 3/4" x 19 3/4" H



06
Frame Round Planter PT2 Round Tall Perforated body and frame in Pale Eucalypt Green.
500Ø x 700H | Ø19 3/4" x 27 1/2" H



03
Frame Planter PT3 Square Solid body and frame in Woodland Grey.
1000L x 1000W x 560H | 39 3/8" W x 39 3/8" L x 22" H



04
Frame Planter PT3 Square XL Solid body and frame in Dusty Pink.
1000L x 1000W x 800H | 39 3/8" W x 39 3/8" L x 31 1/2" H



07
Frame Round Planter PT2 Round Large Solid body and frame in Pioneer Red.
700Ø x 500H | Ø27 1/2" x 19 3/4" H



08
Frame Round Planter PT2-BAT Round XL, Batted Aluminium Curly Birch battens with Core Ten frame.
1000Ø x 800H | Ø39 3/8" x 31 1/2" H

frame planter

For further tailoring, contact us to speak with a sales consultant.

Australia 1800 027 799
 United States +1 212 763 0174
 International +61 2 8774 8888
 Email info@streetfurniture.com

How to order in 7 steps

Select one per category to specify your product.

1. Select planter shape and size

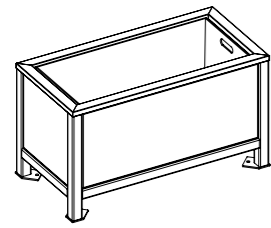

Rectangular
 1000L x 500W x 560H
 19 3/4" W x 39 3/8" L x 22" H

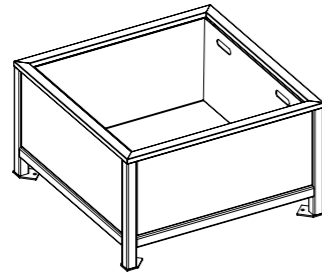

Square
 1000L x 1000W x 560H
 39 3/8" W x 39 3/8" L x 22" H

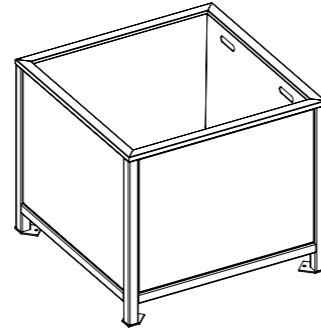

Square XL
 1000L x 1000W x 800H
 39 3/8" W x 39 3/8" L x 31 1/2" H



Round
 500Ø x 500H
 Ø19 3/4" x 19 3/4" H

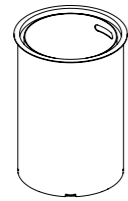

Round Tall
 500Ø x 700H
 Ø19 3/4" x 27 1/2" H

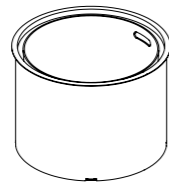

Round Large
 700Ø x 500H
 Ø27 1/2" x 19 3/4" H

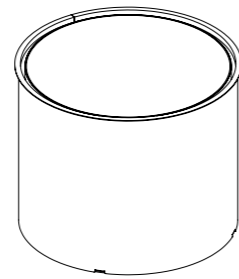

Round XL
 1000Ø x 800H
 Ø39 3/8" x 31 1/2" H

2. Select body option



Solid

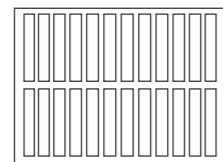

Slots perforation



Battened

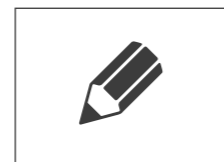

Tailored

3. Select batten colour



*Timber requires oiling every three months.

4. Select frame colour

For the full colour chart, go to streetfurniture.com/colour-chart

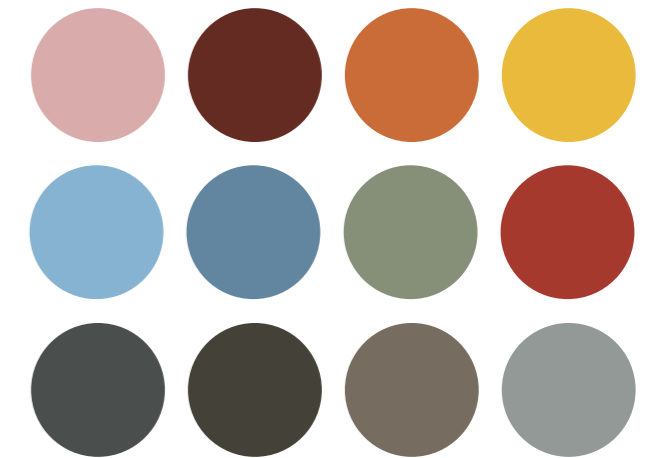

Colours shown are indicative only, variations may occur in printing.

5. Select liner

- Black polyliner (standard for Rectangular and Square planter)
- Black aluminium liner (standard for Square XL and all Round planters)
- Tailored

6. Select drip tray

- No
- Yes (fee applies)

7. Select mounting

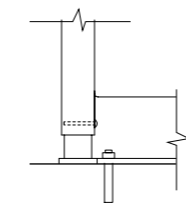

Surface fixed with adjustable leg

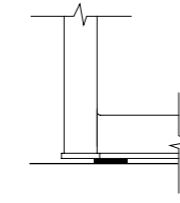

Freestanding

silva tree surrounds

Silva tree guard and grate system, constructed of cast aluminium and high-strength steel posts. Guard and grate are fitted together with a unique foot bracket. Supplied in halves and bolted together on-site for easy installation.

silva tree surrounds

For further tailoring, contact us to speak with a sales consultant.

Australia 1800 027 799
United States +1 212 763 0174
International +61 2 8774 8888
Email info@streetfurniture.com

How to order in 4 steps

Select one per category to specify your product.

1. Select product

- Silva Grate (GR2)
1210L x 1210W (mm)
47 5/8"L x 47 5/8"W

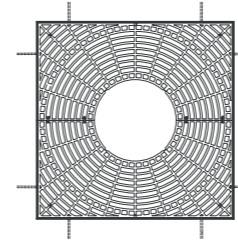

- Silva Guard (TG6)
ø 725 x 1395H (mm)
ø 28 9/16" x 54 15/16"H

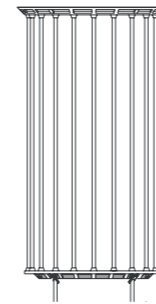

- Silva Integrate System (TG6-GR2)
1210L x 1210W x 1395H (mm)
47 5/8"L x 47 5/8"W x 54 15/16"H

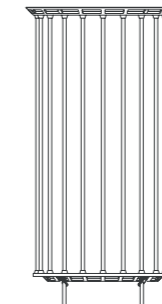

Silva Guard (TG6)

Silva Grate (GR2)

2. Select frame (for Silva Grate)

- Stainless 304 Angle Frame
- Tailored

3. Select finish

- Powder coated (see colour chart at streetfurniture.com/colour-chart/)
- Tailored

4. Select mounting (for Silva Guard)

- Push-fit spikes in ground
- Bolt to Silva Grate
- Tailored



JOIN streetchat

Get news, trends and tips
on furnishing the public realm at
streetfurniture.com/streetchat

Australia 1800 027 799
United States + 1 212 763 0174
International +61 2 8774 8888

Email info@streetfurniture.com
N6 391 Park Road, Regents Park
NSW 2143, Australia



streetfurniture.com

