

Our most premium range features vertical quarter-bullnose timber battens supported by incredibly strong stainless steel frames. Available in many colours and mounting types, including a wall-top option.

For tailored curves, the minimum internal radius is 1 metre or 39 3/8".

MCODE:  
LVB6-C

**AL** Arc Length (outermost)  
**CL** Chord Length  
**ER** External Radius  
**IR** Internal Radius

OVERALL DIMENSIONS:  
635W x 430H x 1930CL (mm)  
25" W x 17" H x 76" CL

WEIGHT:  
*Approximate only and depends on materials selected.*  
40 kg - 48 kg | 88 lbs - 106 lbs

Select one box per category to specify your product.

#### LEG AND MOUNTING:

- Standard Leg
  - Surface fixed
  - Subsurface fixed
  - Freestanding
- Concave Wall
  - Fixed to side of wall
- Convex Wall
  - Fixed to side of wall
- Plinth
  - Fixed on top of wall

#### BATTEN:

Street Furniture Australia uses sustainable timber from certified managed forests. Timber requires oiling every three months.

Australian Spotted Gum, hardwood oiled (PEFC)

#### FRAME:

Stainless 304 powder coated (*see colour chart*)

*Some options incur additional fees and lead time.*

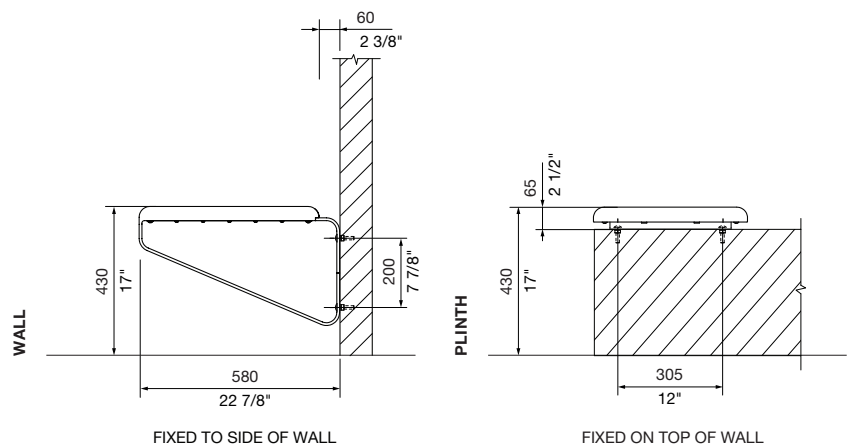
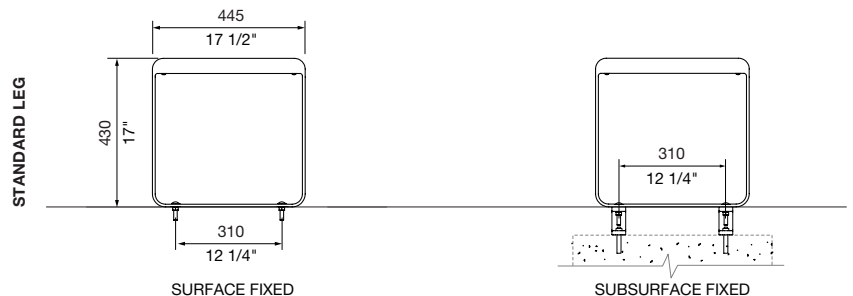
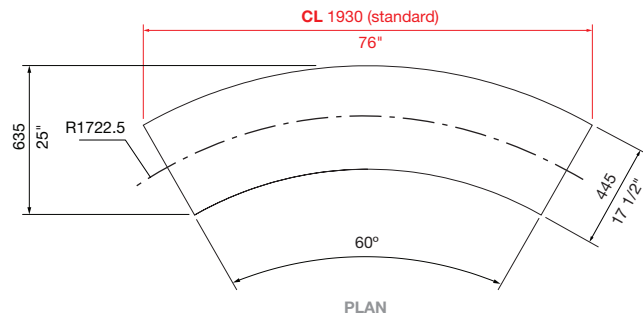
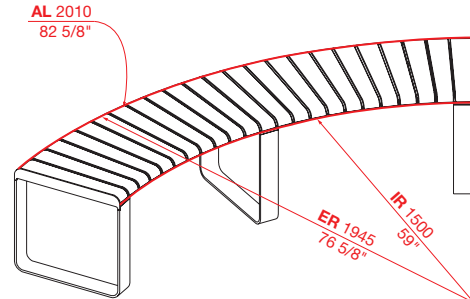

SIDE VIEW

**Need more information?**

For a brochure, image gallery, CAD downloads, installation and maintenance guides, go to:

[streetfurniture.com/product/linea-vt-curved-bench/](https://streetfurniture.com/product/linea-vt-curved-bench/)

**Quick links:**

[streetfurniture.com/au/colour-chart/](https://streetfurniture.com/au/colour-chart/)

[streetfurniture.com/au/warranty/](https://streetfurniture.com/au/warranty/)

[streetfurniture.com/au/parts-promise/](https://streetfurniture.com/au/parts-promise/)

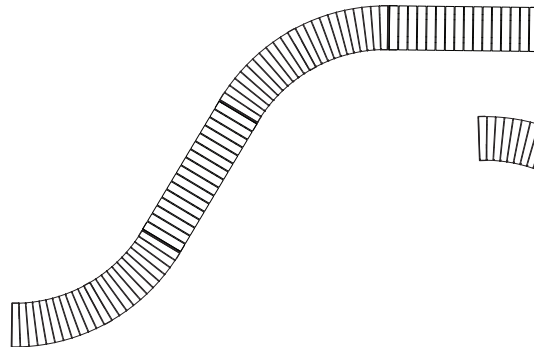

EXTENDED S-SHAPE  
QTY: 2 CURVED BENCHES + 2 BENCHES  
3490 W x 5250 L (mm)  
137 3/8" W x 206 3/4" L

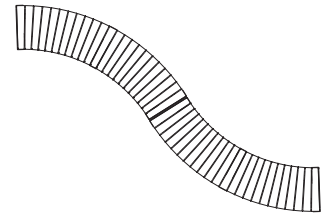

S-SHAPE  
QTY: 2 CURVED BENCHES  
2180 W x 3000 L (mm)  
85 7/8" W x 118 1/8" L

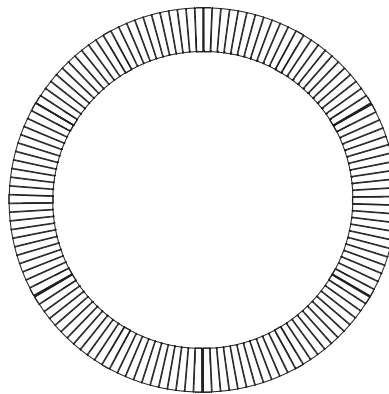

CIRCLE  
QTY: 6 CURVED BENCHES  
ø3905 mm  
ø153 3/4"

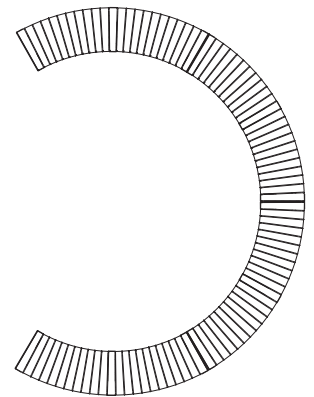

C-SHAPE  
QTY: 4 CURVE BENCHES  
2925W x 3905L (mm)  
115 1/8" W x 153 3/4" L

**CONFIGURATION EXAMPLES**