

bollards



bringing lasting enjoyment
to public places



Scan QR code for a video on how to remove in-ground bollards.

contents

pipe bollards

Slim Bollard	03
Wide Bollard	05
Wide LED Bollard	07

cast aluminium bollards

Traditional Bollard	09
Victorian Bollard	11

Slim Bollard (B14.4 Slope), Removable In-Ground



Victorian Bollard, Removable In-Ground

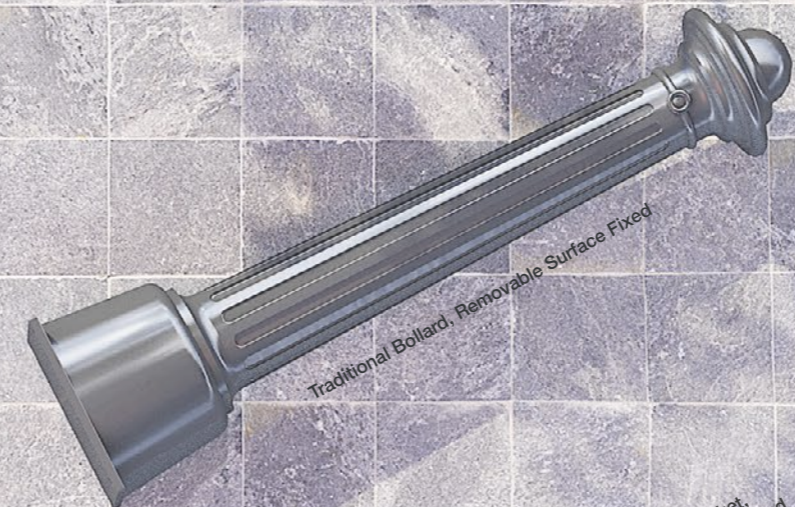

Traditional Bollard, Removable Surface Fixed



Removable Surface Fixed Socket



Pavement Socket, Removable In-Ground



Removable In-Ground Socket, Slim



Slim Bollard (B5 Dome), Removable Surface Fixed



Removable In-Ground Socket, Slim



Pavement Socket, Removable In-Ground



Removable Surface Fixed Socket



Wide Bollard, Removable In-Ground

new removable designs

Install and remove your bollard with ease. These new removable designs will give you full control over security. Pavement socket installed flush with footpath to eliminate trip hazard when bollard is removed.

Orange Regional Museum, NSW, designed by Urbis and Sitedesign Studios.
Slim Bollard (SLIM) with flat head, aluminium anodised finish.



slim



01

Slim Bollard B5-F FLAT

Polished aluminium head.
Stainless steel body and plate.

Ø 115L x 850H
Ø 4 1/2" L x 33 7/16" H



02

Slim Bollard B5 DOME

Polished aluminium head.
Night Sky powder coated body and plate.

Ø 115L x 875H
Ø 4 1/2" L x 34 7/16" H



03

Slim Bollard B14-4 SLOPE

Polished aluminium head and collar.
Pearl White powder coated body and plate.

Ø 115L x 965H
Ø 4 1/2" L x 38" H



Slender bollards with a choice of three uniquely cast tops.

Three cast aluminium heads: Flat, Dome and Slope, are available. Use stainless steel 316 for seaside locations.

Mounting options

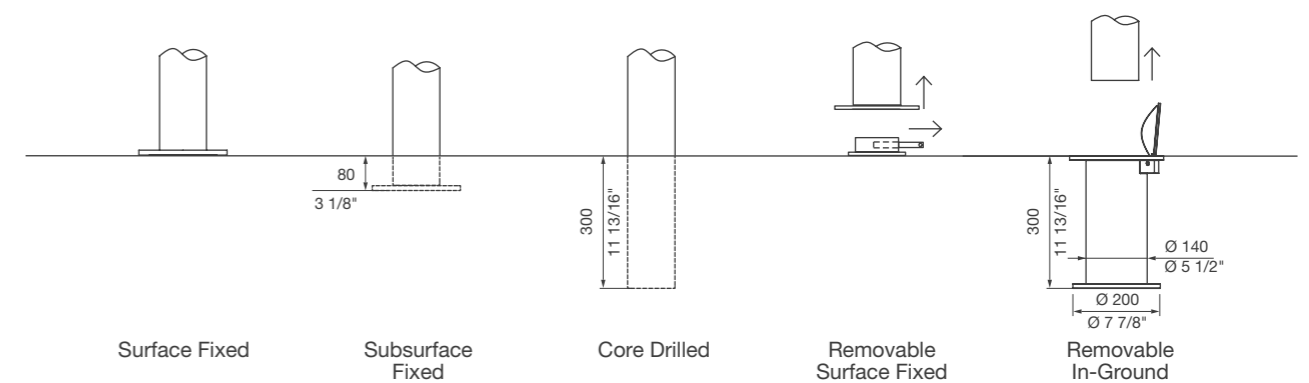

Home of the Arts, Gold Coast, QLD, designed by CUSP, ARM Architecture and Topotek 1.
Wide Bollard, flat head and single collar. Anodised aluminium head and Night Sky body.



wide



01
Wide Bollard B8 FLAT

Polished aluminium head.
Palladium Silver body and plate.

Ø 165L x 790H
Ø 6 1/2" L x 31 1/8" H



02
Wide Bollard B3F FLAT

Polished aluminium head and collar.
Mercury Silver powder coated body and plate.

Ø 165L x 830H
Ø 6 1/2" L x 32 11/16" H



03
Wide Bollard B2F FLAT

Polished aluminium collar.
Night Sky powder coated head, body and plate.

Ø 165L x 870H
Ø 6 1/2" L x 34 1/4" H



04
Wide Bollard B3 DOME

Polished aluminium head and collar.
Wizard powder coated body and plate.

Ø 165L x 880H
Ø 6 1/2" L x 34 5/8" H



Constructed from high-strength aluminium or stainless steel pipe. Five stylish cast aluminium tops are available.

Use stainless steel 316 for seaside locations.

Mounting options

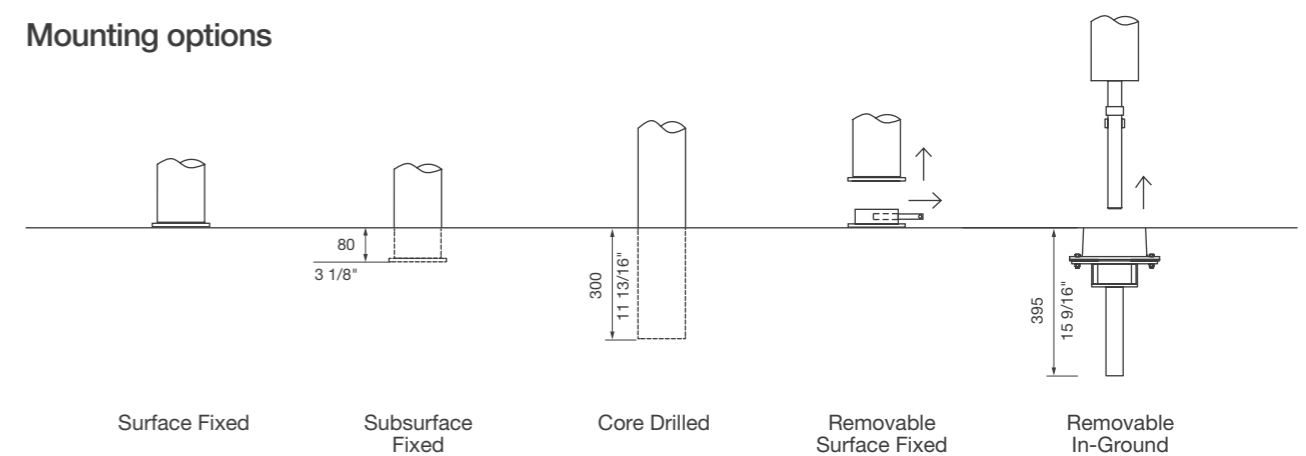

Wide LED Bollard (BL3 DOME) with Polished aluminium head and collar and Night Sky powder coated body and plate.



wide led



01

Wide LED Bollard BL3 DOME

Polished aluminium head and collar.
Night Sky powder coated body and plate.

Ø 165L x 980H

Ø 6 1/2" L x 38 9/16" H



02

Wide LED Bollard BL3F FLAT

Polished aluminium head and collar.
Wizard powder coated body and plate.

Ø 165L x 925H

Ø 6 1/2" L x 36 7/16" H



03

Wide LED Bollard BL3F FLAT

Polished aluminium head and collar.
Palladium Silver powder coated body and plate.

Ø 165L x 925H

Ø 6 1/2" L x 36 7/16" H



Ideal for public safety, an energy-efficient and stylish outdoor feature. Complies with category P4 in AS/NZS 1158.3.1.

Flat and Dome heads are available. Use stainless steel 316 for seaside locations.

Mounting options

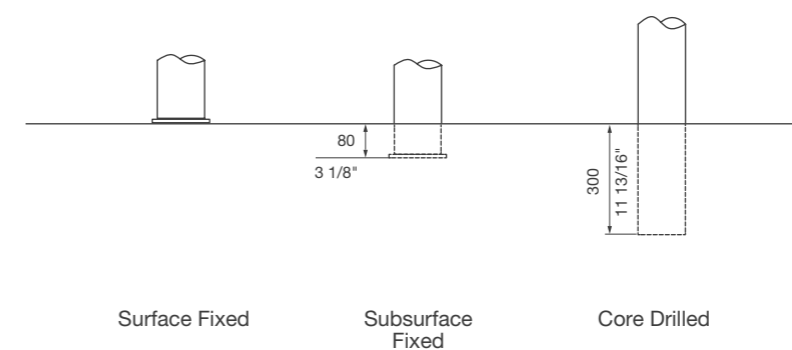



Chester Hills, NSW.
Traditional Bollard with Claret finish.

traditional



01
Traditional Bollard B4

Night Sky powder coated finish.
250L x 250W x 940H
9 13/16" W x 9 13/16" H x 37" L



02
Traditional Bollard B4

Herritage Green powder coated finish.
250L x 250W x 940H
9 13/16" W x 9 13/16" H x 37" L



03
Traditional Bollard B4

Palladium Silver powder coated finish.
250L x 250W x 940H
9 13/16" W x 9 13/16" H x 37" L



Our best-selling bollard offers timeless appeal.

Mounting options

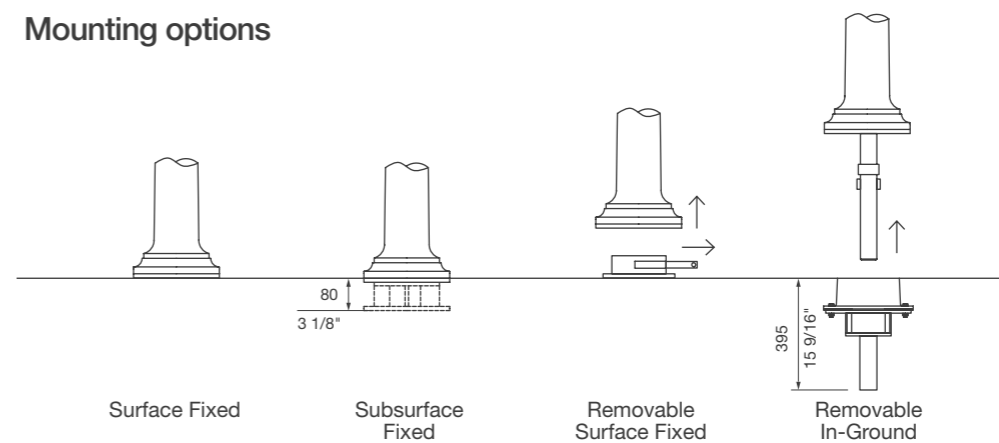



victorian



01

Victorian Bollard B1

Monument powder coated finish.

215W x 215H x 900L
8 7/16" W x 8 7/16" H x 35 7/16" L



02

Victorian Bollard B1

Night Sky powder coated finish.

215W x 215H x 900L
8 7/16" W x 8 7/16" H x 35 7/16" L



03

Victorian Bollard B1

Palladium Silver powder coated finish.

215W x 215H x 900L
8 7/16" W x 8 7/16" H x 35 7/16" L



This heritage-style bollard is elegant and practical.

Mounting options

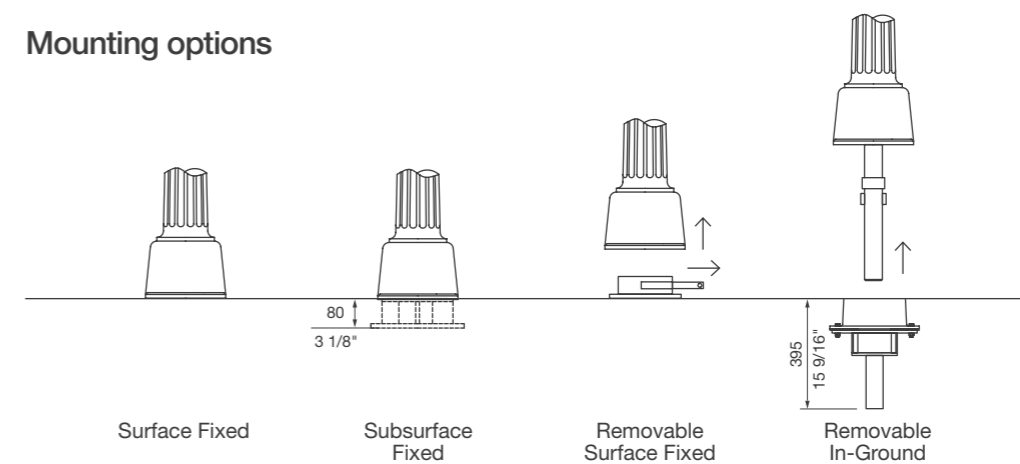



textura

Keep bollards clean with this anti-mar powder coated finish.

bollards

Slim | Wide | Wide LED | Traditional | Victorian

For further tailoring, contact us to speak with a sales consultant.









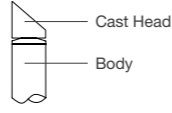

Australia 1800 027 799
 United States +1 212 763 0174
 International +61 2 8774 8888
 Email info@streetfurniture.com

How to order in 4 steps

Select one per category to specify your product.

PIPE BOLLARD

1. Select Product and Cast Head

- Slim
 -  B5-F FLAT
 -  B5 DOME
 -  B14-4 SLOPE
- Wide
 -  B8 FLAT No Collar
 -  B3F FLAT Single Collar
 -  B2F FLAT Double Collar
 -  B3 DOME Single Collar
 -  B2 DOME Double Collar
- Wide LED
 -  BL3F FLAT
 -  BL3 DOME

2. Select Material and Finish

a. Head

- Cast Aluminium Polished (standard)
- Powder Coated (see colour chart)

b. Pipe

- Aluminium Powder Coated
- Stainless 304 No.4 (brushed)
- Stainless 316 No.4 (brushed)

3. Mounting

- Surface Fixed
- Subsurface Fixed
- Core Drilled
- Removable Surface Fixed*
- Removable In-Ground*

*not applicable for Wide LED Bollard

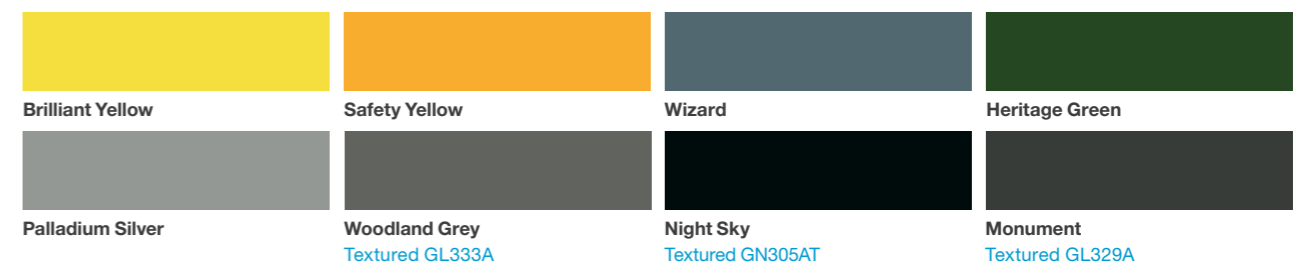

4. Select head, body and pipe colour

More colours can be found on the colour chart at streetfurniture.com/au/colour-chart



CAST ALUMINIUM BOLLARD

1. Select Product

- Traditional
 -  B4
- Victorian
 -  B1

2. Select Material and Finish

a. Cast Body

- Cast Aluminium Powder Coated (see colour chart)

3. Mounting

- Surface Fixed
- Subsurface Fixed
- Core Drilled
- Removable Surface Fixed
- Removable In-Ground

The Mill at Moreton Bay, QLD.
Wide Bollard (WIDE) with flat head and no collar in stainless steel finish and body in Sable Bass.



Oran Park, Sydney, NSW.
Slim Bollard (SLIM) with slope head in stainless head and body.



Kiaora Place, NSW.
Slim Bollard (SLIM) with flat head and single collar in stainless finish.

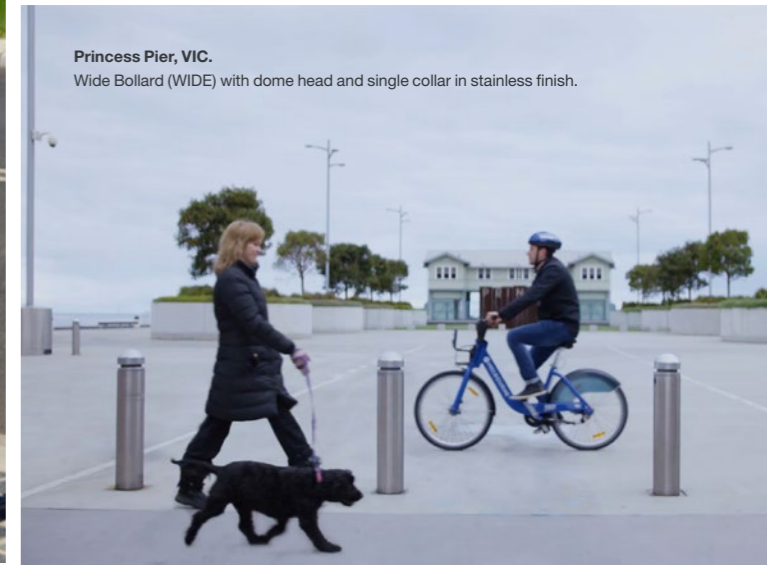

Princess Pier, VIC.
Wide Bollard (WIDE) with dome head and single collar in stainless finish.



Storey Park Community Centre, NSW.
Wide Bollard (WIDE) with dome head and single collar in stainless head and body in Night Sky finish.

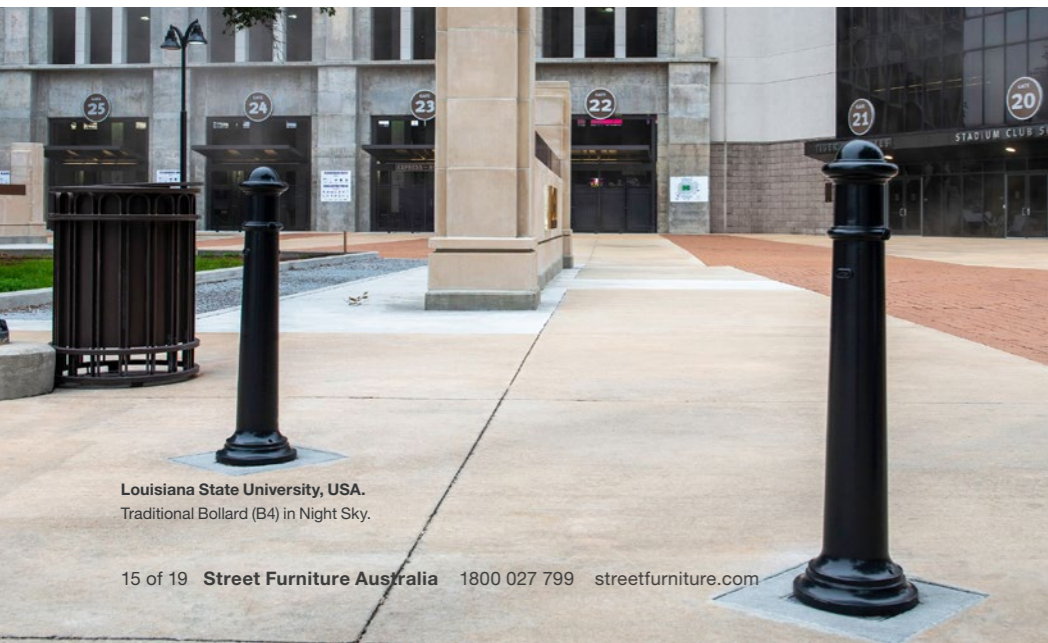









Louisiana State University, USA.
Traditional Bollard (B4) in Night Sky.

colour chart

DuraBright Range

UV stable, fade-resistant bright colours. Adheres to EFSG.

			
Lobster Red Satin YG154A	Sensation Orange Gloss YF049A	Jaybird Blue Satin YJ175A	Bondi Blue Gloss YJ046A
			
Brilliant Yellow Gloss YE087A	Shamrock Green Gloss YK043A	Viper Green Gloss YK051A	Lydra Strip Green Gloss YK063A

Solid Range

Standard colour selection.

			
Pearl White Gloss GA078A	Night Sky Satin GN121A	Palladium Silver Satin GY184C	Dark Bronze Matt 9068184K
			
Monument Satin GP129A	Charcoal Metallic GM019A	Woodland Grey Matt GL205A	Jasper Satin GT114A
			
Deep Ocean Satin GQ103A	Wizard Gloss GJ054A	Ironstone Satin GP136A	Mercury Silver* Gloss GW003K
			
Heritage Green Gloss GK044A	Dark Violet** Gloss 98451926	Telemagenta Pink** Jotun Telemagenta Glos RAL4010	Safety Yellow Gloss ME096A
			
Pale Eucalypt Green Satin GS136A			

* Mercury Silver is flat and non-metallic.

** Pink and Violet may fade under high sun exposure over time.

Proudly supporting
Australian manufacturing.

Watch the factory in action:
streetfurniture.com/au/videos

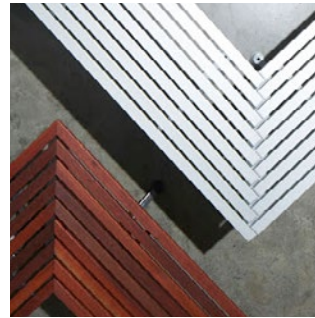
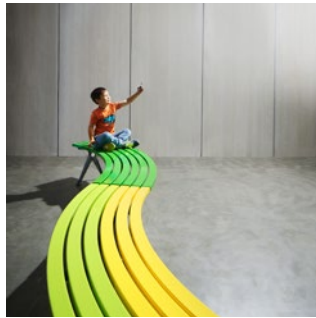
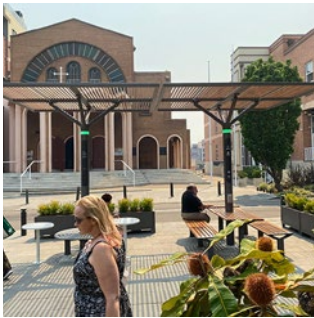
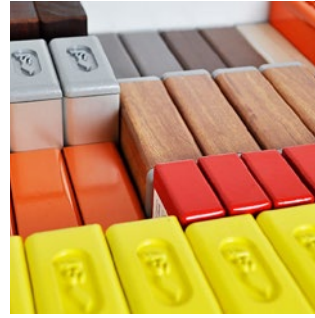
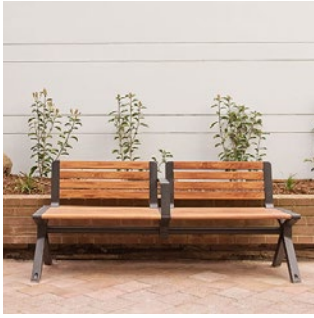

JOIN streetchat

Get news, trends and tips
on furnishing the public realm at
streetfurniture.com/streetchat

Australia 1800 027 799
United States + 1 212 763 0174
International +61 2 8774 8888

Email info@streetfurniture.com
N6 391 Park Road, Regents Park
NSW 2143, Australia



streetfurniture.com

 Australian Institute of
Landscape Architects
Supporting Corporate Partner

 American Society of
Landscape Architects
Corporate Member No.1173455