

litter solutions

street furniture™ handbook



street
furniture
australia

contents

01 round bins

To fit an 80L liner (included) 05

02 bin enclosures

To fit a 120L or 240L wheeled bin container 15

03 ash receptacles

Mount to walls, posts and bins 35

04 parts and accessories

Warranty, parts and accessories 37

Products shown may be subject to change due to our commitment to continuous product improvement.

introducing textura

Keep bins clean with this scratch-resistant powder coat finish.



Bush Cherry

Wenge

Spotted Gum

Beach Oak (Grey)

Curly Birch

wood without worry

Select woodgrain aluminium
battens for a natural timber look,
with minimal maintenance.

01 round bins

To fit an 80L liner (included)

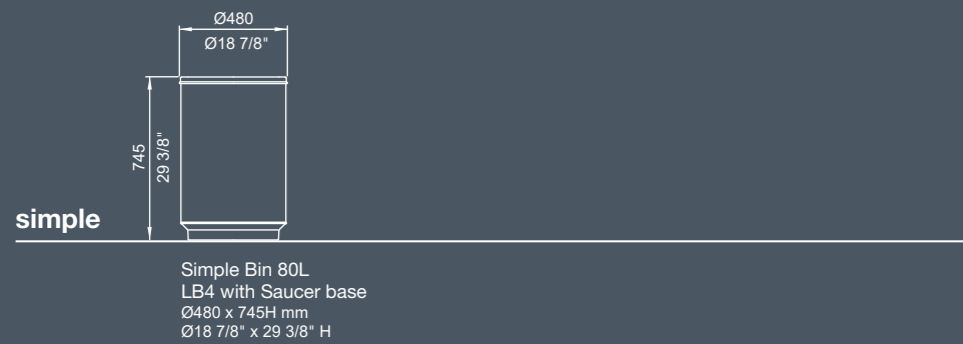
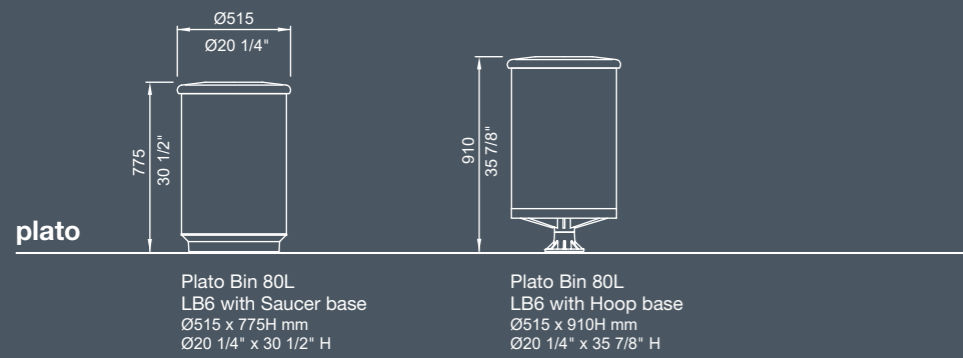
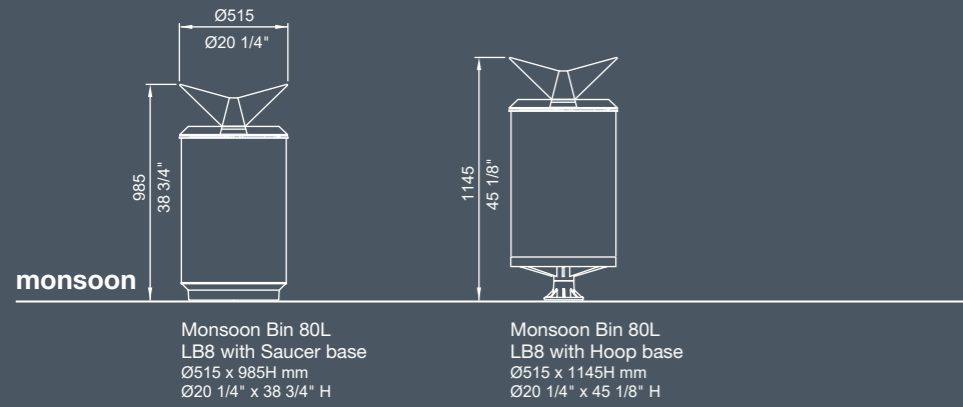

monsoon best-seller



Monsoon Bin 80L, LB8

- ✓ Sprung lid
- ✓ Key operated
- ✓ Available with Hoop base to easily sweep around bin
- ✓ Available with hardwood battens (fee applies)
- ✓ Fluted Body for an anodized metallic look.

plato

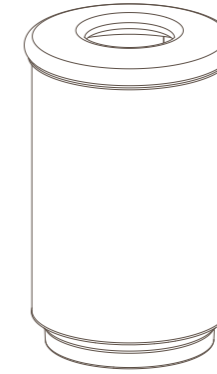

Plato Bin 80L, LB6

- ✓ Sprung lid
- ✓ Key operated
- ✓ Available with Hoop base to easily sweep around bin

simple

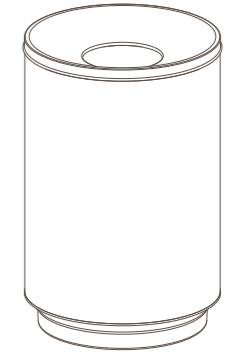

Simple Bin 80L, LB4

- ✓ Spun stainless lid
- ✓ Available with Hoop base to easily sweep around bin
- ✓ Available with hardwood battens (fee applies)
- ✓ Fluted Body for an anodized metallic look.



Forum 1-seater FST, eco-certified hardwood benches with Texture Night Sky castings.

**Specify the Monsoon Bin
with hardwood battens
for timeless elegance.**

Monsoon Bin (LB8) with Saucer base, battered body with Sable Bass roof and frame.

detail matters

Tips for safety, hygiene and usability.

roof
Functional roof sheds rain, deters birds and controls the size of rubbish.

operation
A key-operated sprung lid protects contents and is easy to use.

liner
Stainless 304, optional handle.

round bin LB

How to order in 7 steps

For further tailoring, please call 1800 027 799 to speak with a sales consultant.

1. Select Round Bin



LB4
Simple Bin 80L



LB6
Plato Bin 80L

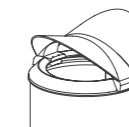

LB8
Monsoon Bin 80L

2. Integrate ash tray? (Y/N)

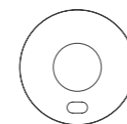

LB4 lid
with optional ash



LB6 lid
with optional ash

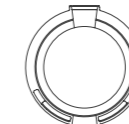

LB8 bezel
with optional ash

3. Select body



Rolled Sheet
• Aluminium (standard)
• Stainless 316 No.4 finish brushed

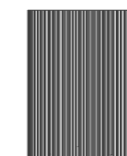

Fluted (Monsoon, Plato only)
• Aluminium anodised
• Aluminium powder coated

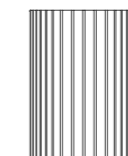

Battened (Monsoon, Simple only)
• Eco-certified hardwood oiled

4. Select perforation (rolled sheet only)



SOLID



STELLAR

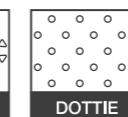

DOTTIE

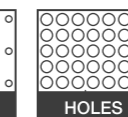

HOLES

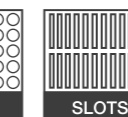

SLOTS

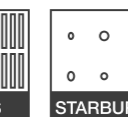

STARBURST

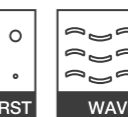

WAVE

5. Select base and mounting

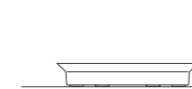

Saucer base
Freestanding or surface-fixed

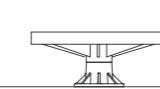

Hoop base*
Surface-fixed

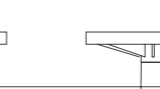

Hoop base*
Subsurface-fixed

*Fits rolled sheet body only.

6. Liner



Stainless 304
(standard)

7. Select colour (if applicable)

For body, roof or base. Roof and base are recommended in a polished (standard) or Textura finish.

More colours can be found on streetfurniture.com/au/colour-chart/



Palladium Silver
Satin GY184C



Ironstone
Satin GP136A *Textured GL336A*



Deep Ocean
Satin GQ103A *Textured GJ301A*



Lobster Red
Satin YG154A



Woodland Grey
Matt GL205A *Textured GL333A*



Dark Bronze
Matt 906 8184K *Textured GY30BA*



Monument
Satin GP129A *Textured GL329A*



Brilliant Yellow
Gloss YE087A

Please note the above colours are not true representations as shade and textural variations may occur.

For further tailoring, contact us to speak with a sales consultant.

Australia 1300 027 799
International +61 412 488 101
Email info@streetfurniture.com

Morsoon Bin (LB9) with fluted body in Telemagenta Pink, Saucer base.



Morsoon Bin (LB9) with fluted body in Telemagenta Pink, Saucer base.



Plato Bin (LB6) with Dottie body in Pearl White, Telemagenta Pink collar and Saucer base.



Stellar



Dottie

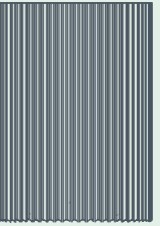

Fluted

3 new bodies

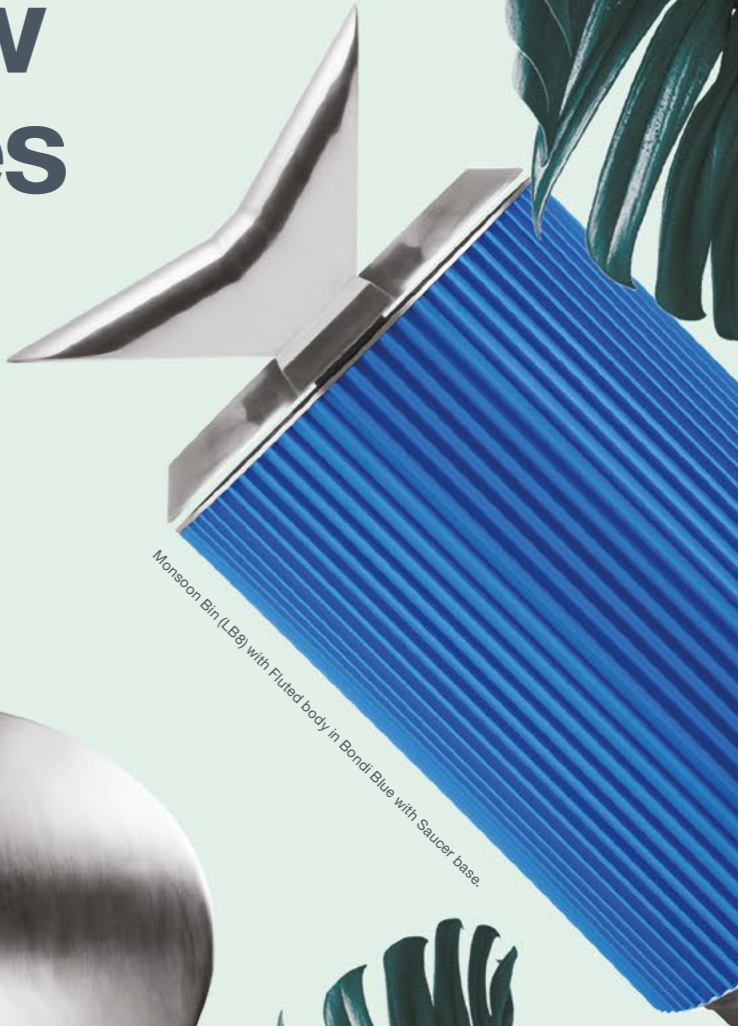

Morsoon Bin (LB9) with Fluted body in Bondi Blue with Saucer base.



Simple Bin (LB4) with Stellar body in Brilliant Yellow.



Plato Bin (LB6) with fluted body, anodised, and Bondi Blue collar.

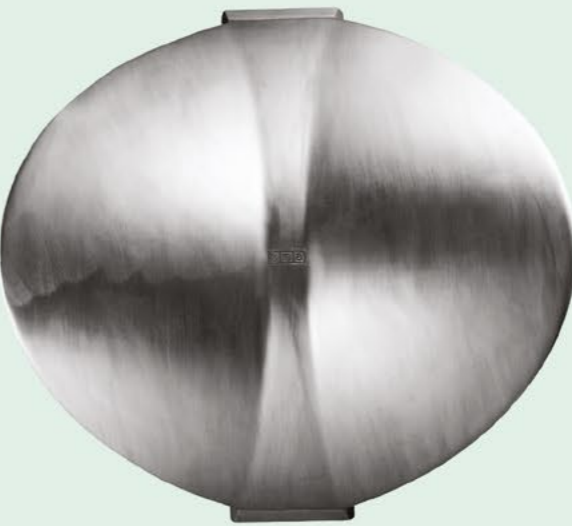



01



04



07



10



02



05



08



11



03



06



09



12



Street Furniture Australia uses sustainably sourced timber from certified managed forests.

01

Simple Bin 80L
LB4 with Saucer base
Stellar body in Brilliant Yellow
Ø480W x 745H mm | Ø18 7/8" W x 29 3/8" H

02

Simple Bin 80L
LB4 with Saucer base
Wave body in Bondi Blue
Ø480W x 745H mm | Ø18 7/8" W x 29 3/8" H

03

Simple Bin 80L
LB4 with Saucer base
Battened body, eco-certified hardwood oiled
Ø480W x 745H mm | Ø18 7/8" W x 29 3/8" H

04

Plato Bin 80L
LB6 with Saucer base
Fluted body, anodised
Bezel in Telemagenta Pink
Ø515W x 775H mm | Ø20 1/4" W x 30 1/2" H

05

Plato Bin 80L
LB6 with Hoop base
Slots body in stainless No.4 finish
Ø515W x 910H mm | Ø20 1/4" W x 35 7/8" H

06

Plato Bin 80L
LB6 with Saucer base
Holes body in Lobster Red
Ø515W x 775H mm | Ø20 1/4" W x 30 1/2" H

bodies

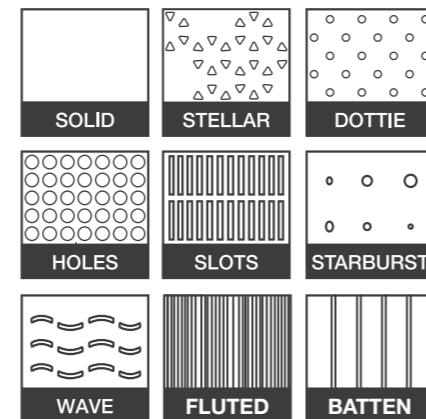

07

Monsoon Bin 80L
LB8 with Saucer base
Wave body in Night Sky
Ø515W x 985H mm | Ø20 1/4" W x 38 3/4" H

08

Monsoon Bin 80L
LB8 with Saucer base
Solid body in stainless No.4 finish
Ø515W x 985H mm | Ø20 1/4" W x 38 3/4" H

09

Monsoon Bin 80L
LB8 with Saucer base
Fluted body, anodised
Bezel in Viper Green
Ø515W x 985H mm | Ø20 1/4" W x 38 3/4" H

10

Monsoon Bin 80L
LB8 with Saucer base
Fluted body in Bondi Blue
Ø515W x 985H mm | Ø20 1/4" W x 38 3/4" H

11

Monsoon Bin 80L
LB8 with Hoop base
Holes body in stainless No.4 finish
Ø515W x 1145H mm | Ø20 1/4" W x 45 1/8" H

12

Monsoon Bin 80L
LB8 with Saucer base
Battened body, eco-certified hardwood oiled
Ø515W x 985H mm | Ø20 1/4" W x 38 3/4" H

bases

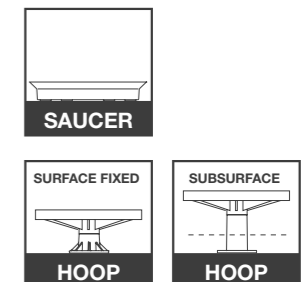

02 bin enclosures

To fit a 120L or 240L wheeled bin container

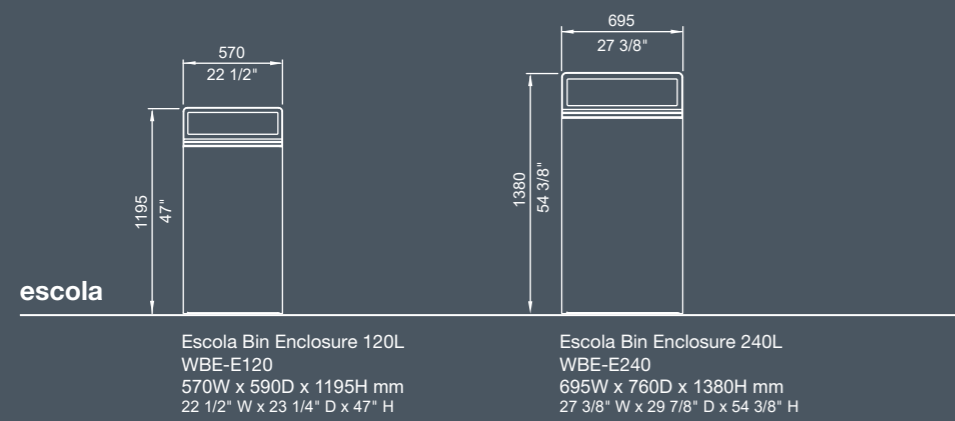
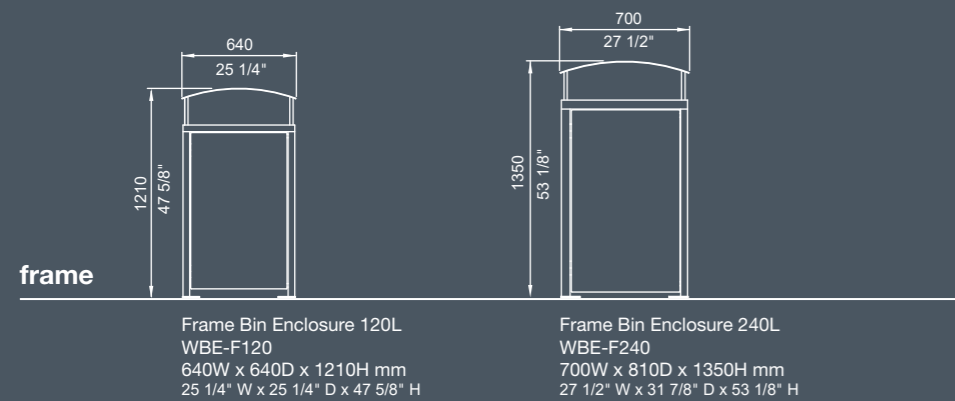

frame

Pages 17-26

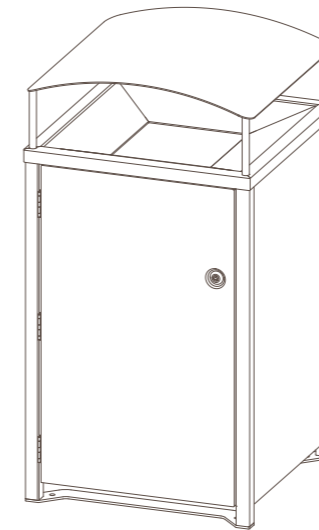

Frame Bin Enclosure WBE-F

- ✓ Most flexible range
- ✓ Fits 120L and 240L
- ✓ Single or dual options

escola

Page 27-34

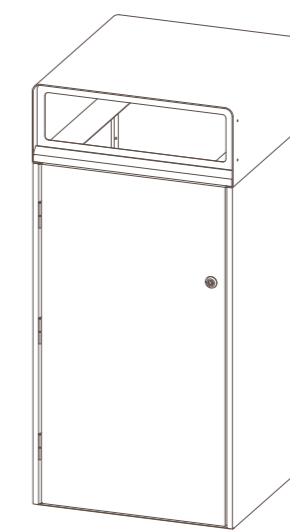

Escola Bin Enclosure WBE-E

- ✓ Newest, most compact design
- ✓ Fits 120L and 240L
- ✓ 100% stainless steel

Frame Bin Enclosures (WB-E-F240 - Dual) with aluminium Spotted Gum battens and Textura Monument frames. Curved top. Recycling and Garbage signage plate.



frame

Specify with aluminium
Wood Without Worry battens
for a timber look with
minimal maintenance.



Brisbane International Cruise Terminal, QLD



Bondi Beach NSW



Perth WA



Shoalhaven, NSW



Princes Pier VIC



Darwin Waterfront Precinct NT



Frame Bin Enclosures perform in numerous seaside locations around Australia.

Cronulla Beach NSW

frame bin enclosure WBE-F

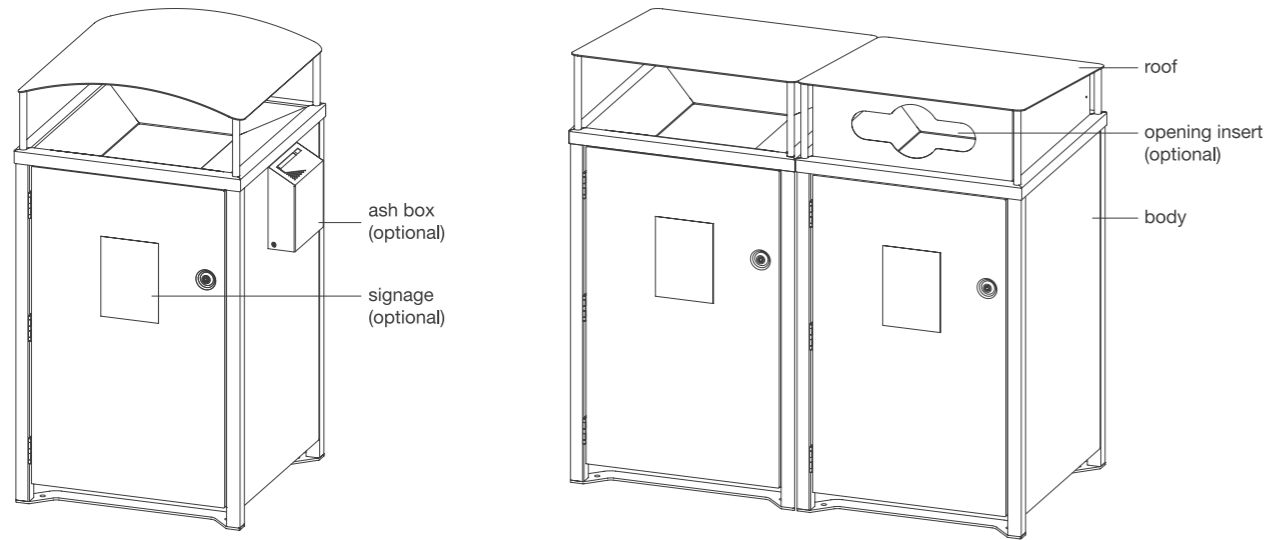

Frame Bin Enclosure with panels
Curved roof, single unit.
120L WBE-F120-PAN | 640W x 640D x 1210H (mm)
240L WBE-F240-PAN | 700W x 810D x 1350H (mm)

Frame Bin Enclosure with panels
Angled roof, dual unit.
120L WBE-F120-WBAT | 1280W x 640D x 1210H (mm)
240L WBE-F240-WBAT | 1400W x 810D x 1350H (mm)

How to order in 10 steps

For further tailoring, please call 1800 027 799 to speak with a sales consultant.

1. Select roof

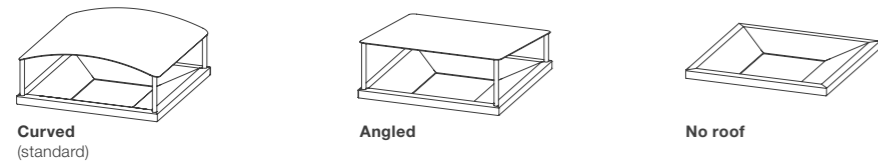

Curved
(standard)

Angled

No roof

2. Select frame

- Powder coated**
(select from colour chart)
- Stainless 304 No.4 finish**
(standard)
- Stainless 316 No.4 finish**
(for seaside locations)

3. Select body

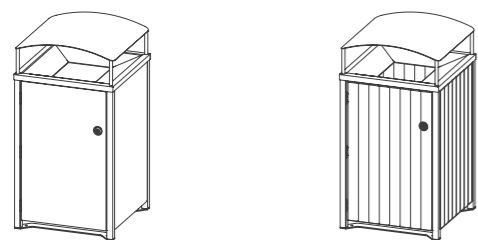

Panels
Sheet 3mm THK

Battens

- Select material**
- Powder coated (standard)
 - Aluminium Woodgrain
 - Stainless 304 No.4 finish
 - Stainless 316 No.4 finish (seaside)

- Select material**
- Eco-certified hardwood, oiled
 - Aluminium anodised
 - Aluminium powder coated
 - Aluminium Woodgrain

4. Select perforations (panels only)

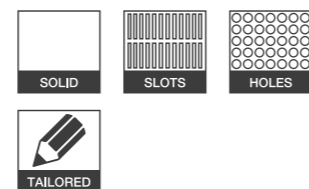

TAILORED

5. Select modules

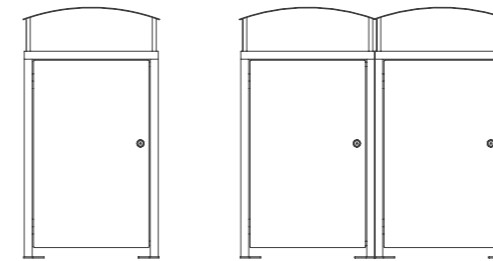

Single

Dual

6. Mounting

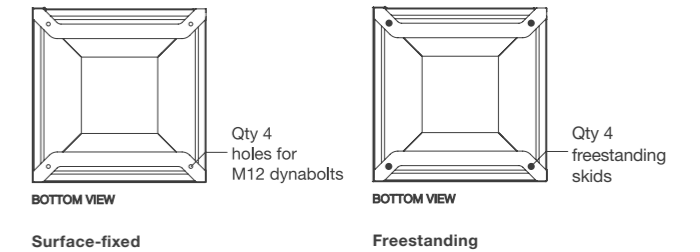

BOTTOM VIEW

Surface-fixed

BOTTOM VIEW

Freestanding

7. Select opening insert (optional)

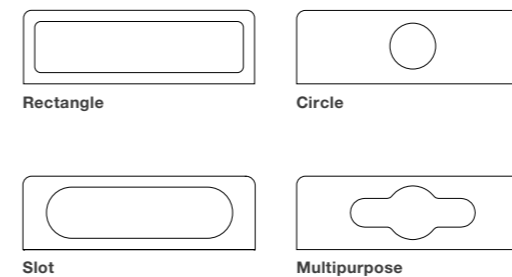

Rectangle

Circle

Slot

Multipurpose

8. Select capacity

Wheelle bin can be purchased separately.



120L

240L

9. Select signage (optional)

Two per bin as standard.

Etched on panel (215x150)

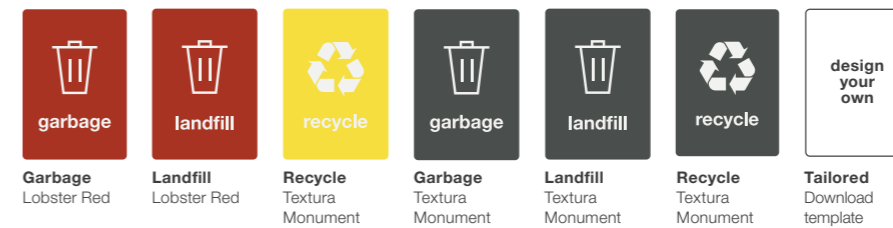

Garbage
Lobster Red

Landfill
Lobster Red

Recycle
Textura Monument

Garbage
Textura Monument

Landfill
Textura Monument

Recycle
Textura Monument

Tailored
Download template

Etched on door

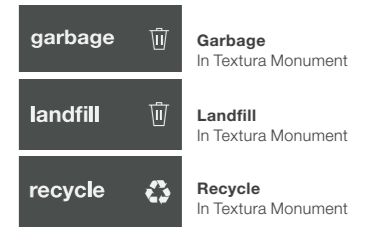

garbage **Garbage**
In Textura Monument

landfill **Landfill**
In Textura Monument

recycle **Recycle**
In Textura Monument

10. Select colour

For roof, frame, body and opening insert (if applicable).

More colours can be found on streetfurniture.com/au/colour-chart/

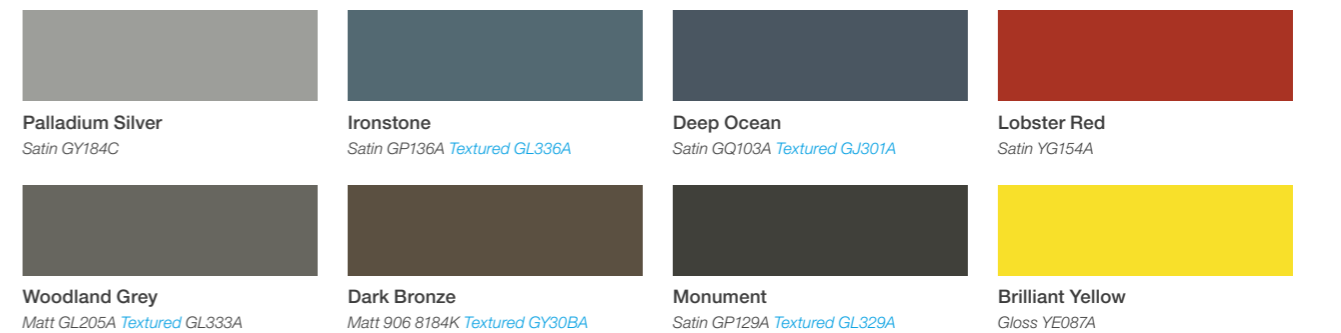

Please note the above colours are not true representations as shade and textural variations may occur.

Create endless custom possibilities with the Frame system.

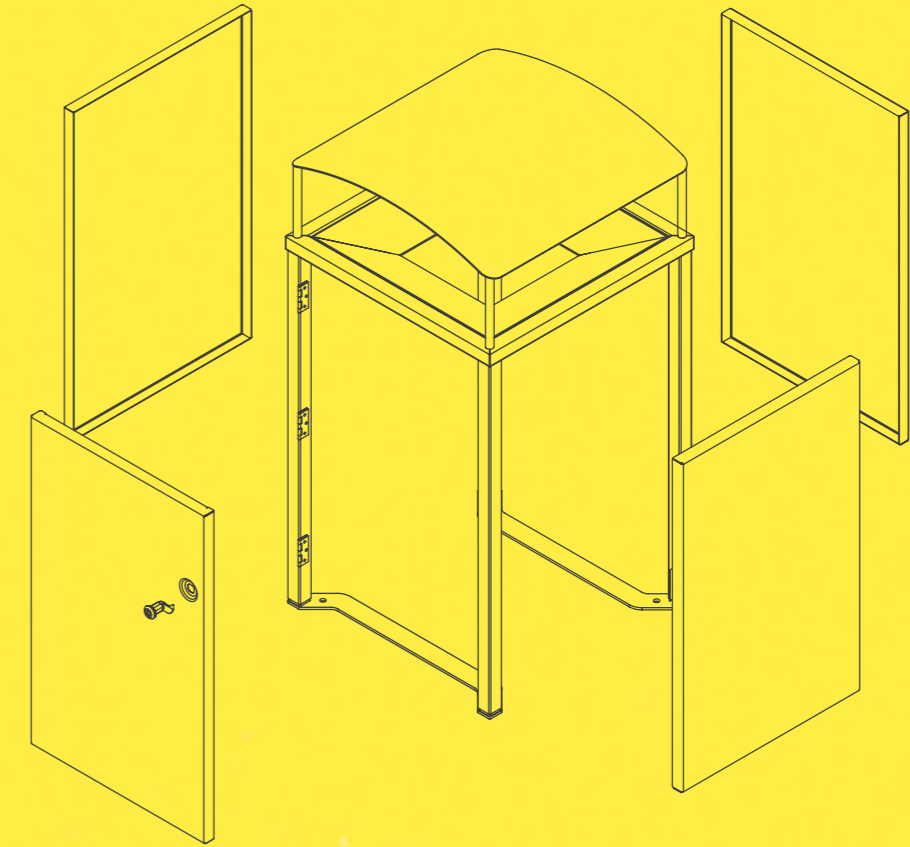

Panels are easily tailored to your requirements.

use local artist
Grey primer for street art and graffiti.

print it
Sublimate or vinyl-wrap images.

go decorative
Laser cut panel with backing.

write it
Sublimated or vinyl lettering.





Street Furniture Australia exclusively uses eco-certified hardwood from sustainably managed forests.



01



02



03



04



05



06

01

Frame Bin Enclosure with panels

Curved roof, stainless frame.
Bondi Blue panel with vinyl lettering.

120L WBE-F120-PAN | 625W x 625D x 1200H (mm)
240L WBE-F240-PAN | 740W x 810D x 1340H (mm)

02

Frame Bin Enclosure with panels

Curved roof, Palladium Silver frame.
Slot body in Textura Night Sky.

120L WBE-F120-PAN | 625W x 625D x 1200H (mm)
240L WBE-F240-PAN | 740W x 810D x 1340H (mm)

03

Frame Bin Enclosure with battens

Angled roof, Textura Night Sky frame.
Battens in hardwood, oiled.

120L WBE-F120-PAN | 625W x 625D x 1200H (mm)
240L WBE-F240-PAN | 740W x 810D x 1340H (mm)

04

Frame Bin Enclosure with panels

Dual unit. Curved roof, Dark Bronze frame. Etched door signage.

120L WBE-F120-PAN | 625W x 625D x 1200H (mm)
240L WBE-F240-PAN | 740W x 810D x 1340H (mm)

05

Frame Bin Enclosure with panels

Dual unit. Angled roof, Textura Monument frame.
Tailored aluminium Spotted Gum side panel.

120L WBE-F120-PAN | 625W x 625D x 1200H (mm)
240L WBE-F240-PAN | 740W x 810D x 1340H (mm)

06

Frame Bin Enclosure with battens

Dual unit. Curved roof, Palladium Silver frame.
Battens in hardwood, oiled. Circle opening insert.

120L WBE-F120-PAN | 625W x 625D x 1200H (mm)
240L WBE-F240-PAN | 740W x 810D x 1340H (mm)

panels

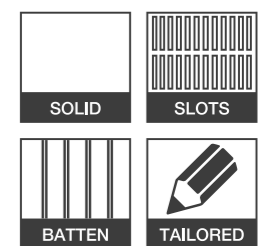

Small bin footprints reduce visual clutter and increase pedestrian safety by improving traffic visibility.

escola

Minimal and compact

Escola Bin Enclosures hide wheeled bin containers with the smallest footprint.





Escola range is
100% stainless steel

escola bin enclosure WBE-E

For further tailoring, contact us to speak with a sales consultant.

Australia 1800 027 799
United States +1 212 763 0174
International +61 2 8774 8888
Email info@streetfurniture.com

How to order in 7 steps

For further tailoring, please call 1800 027 799 to speak with a sales consultant.

1. Select roof

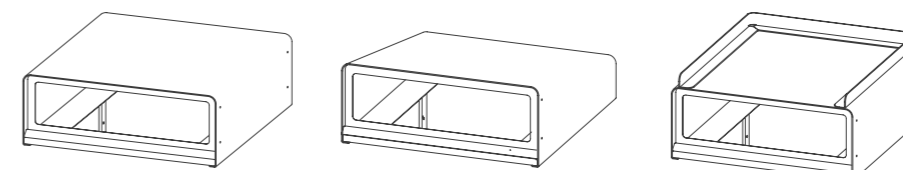

Flat roof

Angled roof

Flat roof with tray return

2. Select body

Stainless 304 No.4 finish (standard)

Stainless 316 No.4 finish (for seaside locations)

3. Select mounting

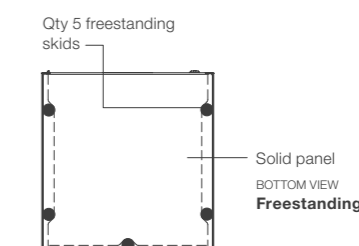
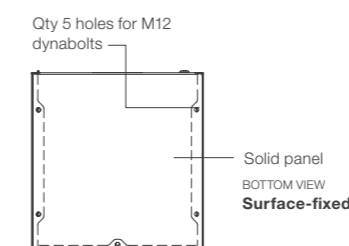

4. Select opening insert

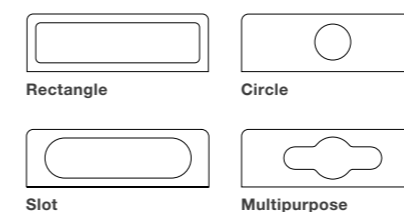

5. Select capacity

Wheelie bin can be purchased separately.



6. Select signage (optional)

Two per bin as standard.

Etched on panel (215x150)

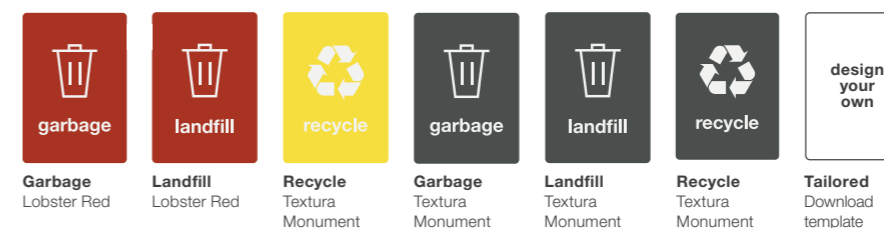

Etched on door

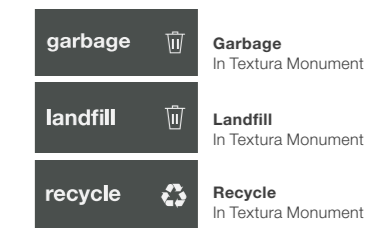

7. Select colour

For roofs and opening inserts (if applicable). More colours can be found on streetfurniture.com/au/colour-chart/

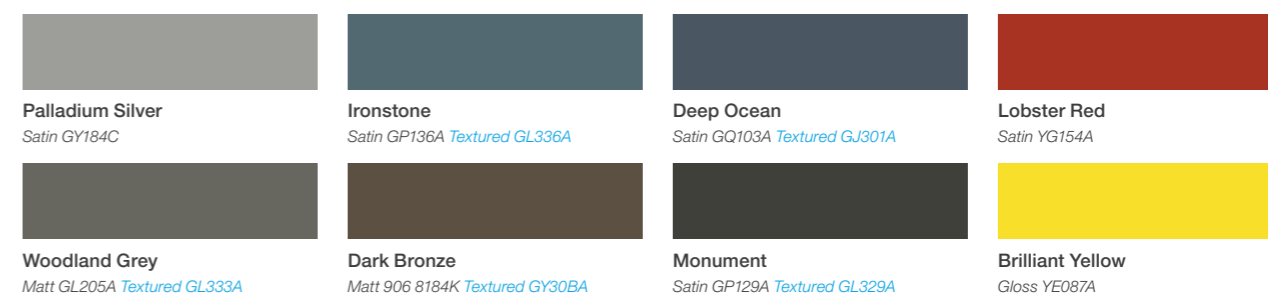

Please note the above colours are not true representations as shade and textural variations may occur.

go smart

Escola eBin is a low-risk way to trial smart bins. Each bin enclosure is fitted with a Superfy sensor to let you know when it is full or reaching maximum capacity. You will also know when it was last emptied, and receive fire alerts for increased safety.

Using Superfy sensor technology, all the data is laid out in an interactive map so even the most remote locations can be managed with ease.

Each Escola eBin comes with 12-month access to the Superfy application available via desktop or phone. The access period can easily be extended directly through Superfy.

Escola eBin saves money, time and the environment. It is a simple and low-risk solution to add smarts to waste management.

All in Escola's popular compact footprint, which reduces visual clutter on the street.

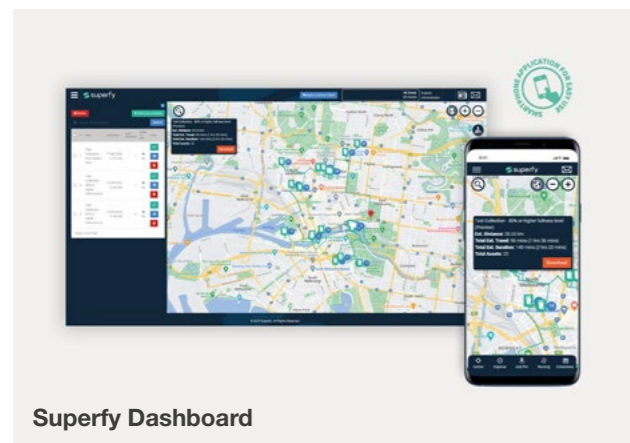
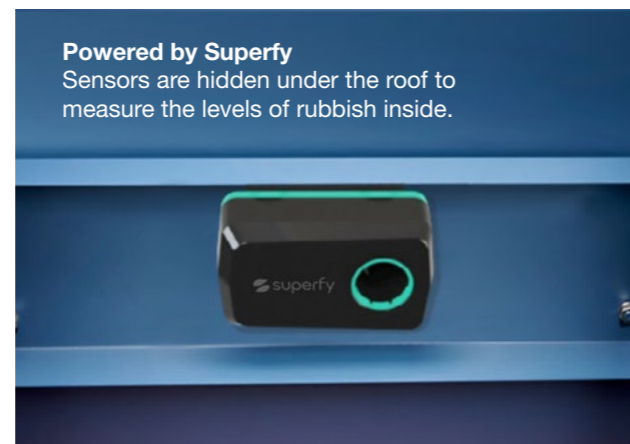

How to activate your bin

- Step 1 | Swipe the magnetic key to activate the sensor. A single 'beep' indicates activation.
- Step 2 | Download the Superfy app or access the dashboard on a web browser.
- Step 3 | Log in with the account details provided.
- Step 4 | Start tracking and customise your dashboard.



Add a tray return attachment for food court environments.

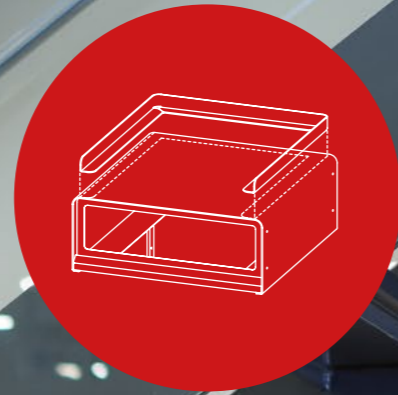

01



02



03



04



05



06



01

Escola Bin Enclosure

Flat roof in Textura Monument.
Rectangle opening insert in Telemagenta Pink.
120L WBE-E120 | 570W x 590D x 1195H (mm)
240L WBE-E240 | 695W x 760D x 1380H (mm)

02

Escola Bin Enclosure

Angled roof in Textura Monument.
Circle opening insert in Shamrock Green.
120L WBE-E120 | 570W x 590D x 1195H (mm)
240L WBE-E240 | 695W x 760D x 1380H (mm)

03

Escola eBin Enclosure

Flat roof and body in Textura Monument.
Slot opening insert in Jaybird Blue.
120L EBIN-E120 | 570W x 590D x 1195H (mm)
240L EBIN-E240 | 695W x 760D x 1380H (mm)

04

Escola Bin Enclosure side by side

Flat roof with tray return, in Brilliant Yellow and Lobster Red. Circle and Rectangle opening inserts. Recycling and Garbage signage.
120L WBE-E120 | 1180W x 570D x 1195H (mm)
240L WBE-E240 | 1390W x 760D x 1380H (mm)

05

Escola Bin Enclosure side by side

Angled roof, body, Slot opening inserts in Textura Dark Bronze and Brilliant Yellow. Signage laser etched on door.
120L WBE-E120 | 1180W x 570D x 1195H (mm)
240L WBE-E240 | 1390W x 760D x 1380H (mm)

06

Escola eBin Enclosure side by side

Angled roof, Rectangle and Circle opening inserts and Lobster Red and Brilliant Yellow. Frame and roof in Textura Woodland Grey. Signage laser etched onto coloured plates.
120L EBIN-E120 | 1180W x 570D x 1195H (mm)
240L EBIN-E240 | 1390W x 760D x 1380H (mm)

03 ash receptacles

Mount to walls, posts and bins

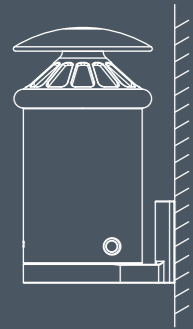

WALL MOUNT

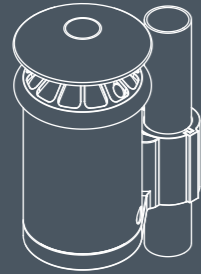

POST CLAMP
(optional)

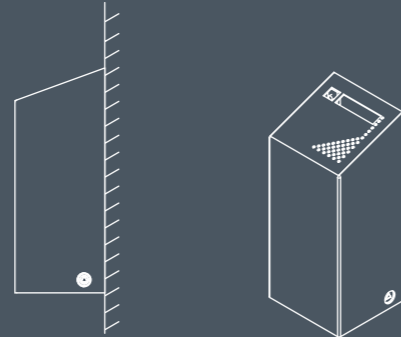

MOUNTS TO FLAT SURFACES

Ash Cylinder

150W x 200D x 300H mm
5 7/8" W x 7 7/8" D x 11 3/4" H

Ash Box

120W x 110D x 225H mm
4 3/4" W x 4 3/8" D x 8 7/8" H

ash cylinder



AC1 3L (1000 butts)

- ✓ Mounts to wall, column or pole (sold separately)
- ✓ Available in many colours
- ✓ Security key operated

ash box



AC5 3L (1000 butts)

- ✓ Newest design
- ✓ Perfect for bin enclosures
- ✓ 100% stainless steel
- ✓ Security key operated

04 parts and accessories

Warranty, parts and accessories

To order spare parts, simply go to streetfurniture.com/order-spare-parts

You can also call **1800 027 799** (free) or email support@streetfurniture.com

key links

Warranty
streetfurniture.com/au/warranty

Colour Chart
streetfurniture.com/au/colour-chart

Maintenance Guide
streetfurniture.com/au/maintenance

frequently asked questions

How durable are your products?

Street Furniture Australia's products are designed and proven to last decades with correct maintenance.

What is your warranty period?

Standard products are warranted for 3 years, and tailored products for 1 year. Our policy can be found at streetfurniture.com/warranty

How do you maintain timber?

Re-oiling is recommended at least every 3 months, depending on site conditions. For a timber look with minimal maintenance we also offer aluminium woodgrain Wood Without Worry battens.

Do you sell spare parts?

Street Furniture Australia ensures that customers are able to purchase spare parts for the entire life of the product, or for a period of up to 5 years after the product has been discontinued.

We believe our responsibility to customers lasts long after installation.



Street Furniture Australia uses sustainably sourced timber from certified managed forests.

aluminium battens

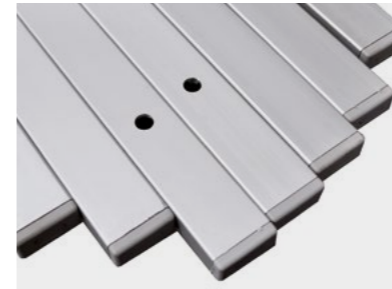

Standard sections include 40x20, 63x30 and 85x30.

Choose from anodised, powder coated or aluminium woodgrain. More colours can be found on streetfurniture.com/au/colour-chart/

hardwood battens



Standard sections include 40x20, 63x30 and 85x30 (mm).

Eco-certified hardwood oiled.

castings



Roofs, lids and bases. More colours can be found on streetfurniture.com/au/colour-chart/

panels

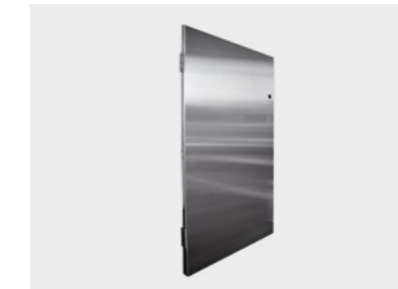

Doors and panels for 120L and 240L bin enclosures. Choose from stainless 304 or 316 No.4 brushed, powder coated or aluminium woodgrain. More colours can be found on streetfurniture.com/au/colour-chart/

signage



Laser etched plate signage. Standard shown as above, or request the template for a tailored design (fee applies).

liner



Poly and galvanised round liners for 55L and 80L bins.

keys



Street Furniture™ Triangular 7mm key for slam lock.

wheelie bin



Wheelie bins (120L or 240L) can be purchased separately.

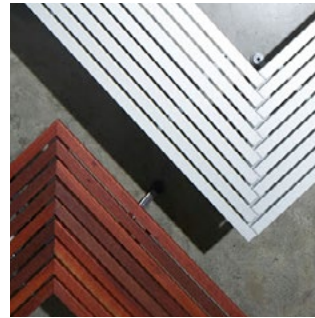
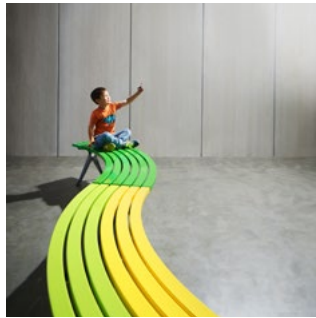
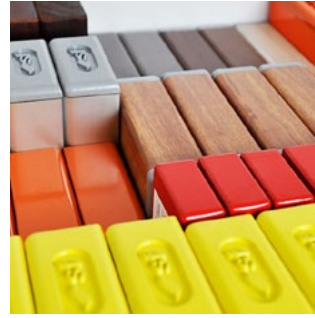
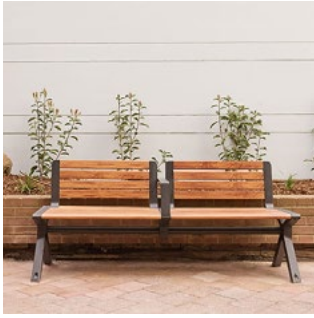

JOIN streetchat

Get news, trends and tips
on furnishing the public realm at
streetfurniture.com/streetchat

Australia 1800 027 799
International +61 2 8774 8888

Email info@streetfurniture.com
N6 391 Park Road, Regents Park
NSW 2143, Australia



streetfurniture.com

