

Make a statement with concave or convex curves. Comfortable yet DDA friendly, the Arc Seat features wide and tapered hardwood battens supported by strong stainless frames. Select full, half or no backrest.

MCODE:
ARC-S

DIMENSIONS (mm):
765W x 795H x various lengths

Select one box per category to specify your product.

CONFIGURATION:

- Concave
 - IR 5500 & CL 2000 (mm)
 - IR 4000 & CL 3000 (mm)
 - IR 1600 & CL 3000 (mm)
- Convex
 - IR 5500 & CL 2000 (mm)
 - IR 4000 & CL 3000 (mm)
 - IR 1600 & CL 3000 (mm)
- Straight
 - 2000 mm
 - 3000 mm
- Tailored

ARM:

- None
- Integral
- Tailored

ARM QUANTITY:

- 2
- 3
- Tailored

FRAME:

- Stainless 304 Powder Coated (see colour chart)
- Tailored

MOUNTING:

- Surface Fixed
- Subsurface Fixed
- Plinth Mount
- Tailored

BATTEN:

Street Furniture Australia uses sustainable timber from certified managed forests. Timber requires oiling every three months.

- Eco-certified Jarrah Hardwood, Oiled (PEFC)
- Eco-certified Cumaru Hardwood, Oiled (FSC)
- Tailored

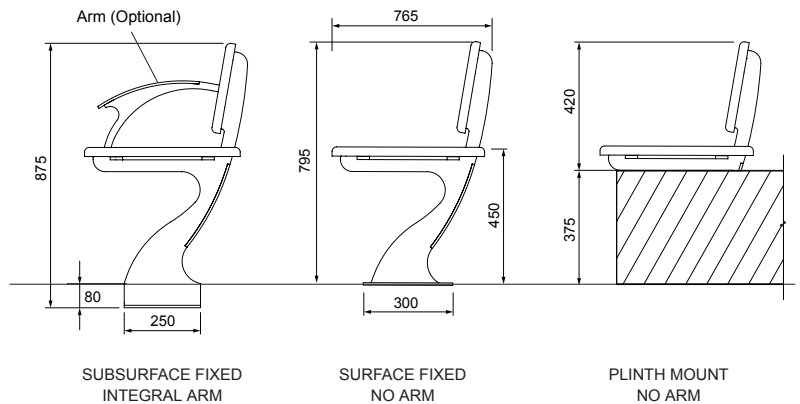

MOUNTING AND ARM OPTIONS

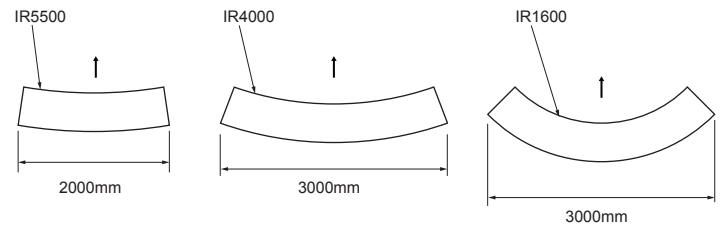

CONCAVE

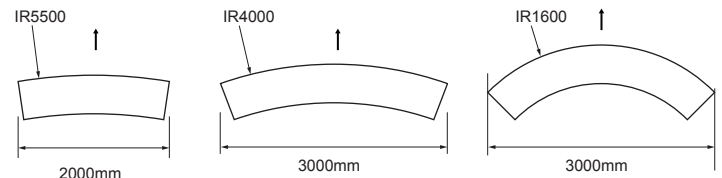

CONVEX

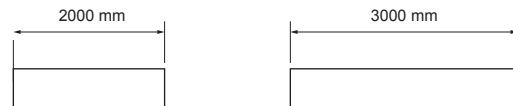

STRAIGHT

CONFIGURATION OPTIONS

BACKREST:

- None (bench)
- Half Left
- Half Right
- Full
- Tailored

Some options incur additional fees and lead time.

Need more information?

For a brochure, image gallery, CAD downloads, installation and maintenance guides, go to:
streetfurniture.com/au/product/arc-seat/

Quick links:

- streetfurniture.com/au/colour-chart/
- streetfurniture.com/au/warranty/
- streetfurniture.com/au/parts-promise/

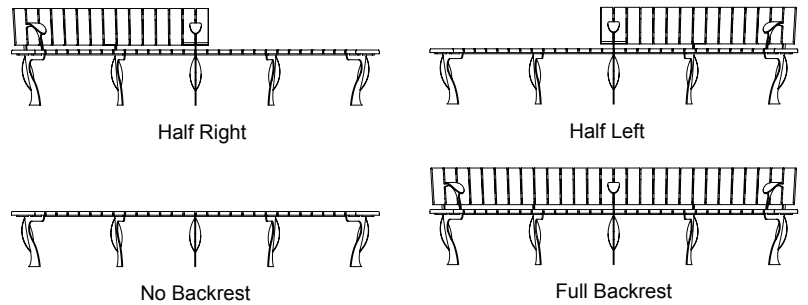

BACKREST OPTIONS

